

LA-5755

C3

UC-70

Reporting Date: September 1974

Issued: January 1975

**REPRODUCTION
COPY**

IS-4 REPORT SECTION

**Demolition of Building 12,
An Old Plutonium Filter Facility**

by

E. L. Christensen

R. Garde

A. M. Valentine

LOS ALAMOS NATL. LAB. LIBS
3 9338 00368 2274



los alamos
scientific laboratory
of the University of California
LOS ALAMOS, NEW MEXICO 87544



An Affirmative Action/Equal Opportunity Employer

**Printed in the United States of America. Available from
National Technical Information Service
U.S. Department of Commerce
5285 Port Royal Road
Springfield, VA 22151
Price: Printed Copy \$4.00 Microfiche \$2.25**

This report was prepared as an account of work sponsored by the United States Government. Neither the United States nor the United States Atomic Energy Commission, nor any of their employees, nor any of their contractors, subcontractors, or their employees, makes any warranty, express or implied, or assumes any legal liability or responsibility for the accuracy, completeness or usefulness of any information, apparatus, product or process disclosed, or represents that its use would not infringe privately owned rights.

DEMOLITION OF BUILDING 12, AN OLD PLUTONIUM FILTER FACILITY

by

E. L. Christensen, R. Garde, and A. M. Valentine

ABSTRACT

This report discusses the decommissioning and disposal of a plutonium-contaminated air filter facility that provided ventilation for the main plutonium processing plant at Los Alamos from 1945 until 1973. The health physics, waste management, and environmental aspects of the demolition are also discussed.



I. HISTORY

A plutonium processing facility was built in Los Alamos in 1944, on what is now known as DP Mesa. The urgency at that time dictated that the facility be built as rapidly as possible, incorporating all the best construction ideas but using only those materials that were readily available.

The process buildings were constructed with sheet metal on 1.22-m-high concrete wainscoting. Plaster, on metal laths over metal studs, was used to give a smooth interior surface.

The buildings were ventilated with a 60 000-m³/min-capacity central air exhaust system. This system handled air from rooms and fume hoods, sparging of dissolvers, and venting of solution tanks. At that time exhausting air from the glove boxes was not believed necessary. Several years later the decision was made to vent these work enclosures. The air was exhausted, without being filtered, through the room air exhaust system. Particulates were removed from the exhaust air by electrostatic precipitron units backed up by a single bank of American Air Filter Company Type PL-24 filters. This system was considered the best available for air clean-up at that time.

The filter building, designated Building 12, was completed and put into service in May 1945. It continued in service for room and process air until July 1, 1959. That year another system was installed for the process air, and afterward only room air was handled in Building 12. Building 12 continued in service until February 1973, when new room air filtration systems were completed, one for each of the process buildings.

II. DESCRIPTION OF FACILITY

The site plan (Fig. 1) shows the relationship of the process buildings to the filter building. The finished site is shown in Fig. 2. The filter building is on the left. Air from the rooms was exhausted from floor level, up vertical ducts through the roof, then to ducts mounted parallel to the roof, to the collector duct on the peak of the roof. All the ductwork was galvanized steel. In those ducts that handled chemical fumes, corrosion began immediately, and small holes formed within a few years. Corrosion products and dirt drawn through the holes in the ductwork were deposited in the plenum of the filter building.

The floor plan of Building 12 is shown in Fig. 3. The floor area for that portion housing the filters and precipitron units was 30.8 m by 19.5 m. The intake plenum was a trapezoidal area 23.5 m wide at its longest base, 7.6 m wide where the air entered the building, and 18.9 m from that point to the rectangular portion of the building.

The precipitron units and filter banks were built in five sections. Each section had two large doors that could be lowered to isolate the area while filters were being changed or while work was being done on the precipitron unit. Access to the isolated section was by ladder from the second story of the building. The second story housed the doors when they were in the raised position.

Figure 4 shows a side view of the building; and Fig. 5, a side view of the filter and blower area, shows the positions of the electrostatic precipitron units, the PL-24 filter bank, the common blower plenum, the exhaust blowers, and the doors used to isolate the sections. A front view of the building is shown in Fig. 6.

The construction of Building 12 was constrained by the materials available at that time. The concrete foundation was made deeper and thicker because reinforcing steel was in short supply. The wall studs and floor and roof beams were wood. They were covered with two layers of gypsum board to give a smooth interior surface. This construction actually helped prevent the spread of contamination during demolition. Construction details will be discussed in Sec. IV.

III. DECONTAMINATION OF FACILITY

In 1960 the interior of the plenum and the largest portion of the air ducts were cleaned. About 3000 kg of dirt were removed from the building during this first cleaning operation, including several hundred pounds of sand that had been used in sandblasting plutonium parts. Samples of dirt removed were analyzed and showed a plutonium content ranging from 0.001 to 0.05 wt%. The data indicated that this dirt, which was packed in two 0.3-mm-thick plastic bags and placed in steel drums for burial, contained about 600 g of plutonium (93.5% ^{239}Pu , 6% ^{240}Pu , and 0.5% ^{241}Pu). The precipitron units were

disassembled, removed from the building, wrapped in several layers of plastic, and packed in plywood crates for burial.

Over the next few years the building was cleaned several times. Each time the final operation was to wipe down the entire floor with wet rags. Immediately after this cleaning, the floor would have a swipe count of only a few hundred disintegrations per minute, but the direct count was still $> 100\,000$ dis/min per 60 cm^2 . All the cracks, such as expansion joints, had a swipe count of $> 100\,000$ dis/min.

IV. DEMOLITION OF BUILDING 12

A proposed procedure for the demolition of the building was prepared by a member of the Engineering group and a member of the Plutonium Processing group. Their report was submitted for approval to the Demolition Committee, which was composed of representatives from the Los Alamos Scientific Laboratory (LASL) and from the contractor that would do the demolition. The names of the groups represented are shown in Table I. Demolition work was started using this approved procedure; but as work progressed, conditions were sometimes encountered that necessitated a change in procedure. Therefore, the Committee met every week to hear progress reports on the demolition and to review proposals for any change in the procedure.

TABLE I

DEPARTMENTS REPRESENTED ON DEMOLITION COMMITTEE

- Plutonium Processing
- Health Physics
- Environmental Studies
- Fire Safety
- Industrial Safety
- Waste Management
- Engineering Planning
- Engineering Estimating
- Transportation
- Engineering Maintenance
- Contractor for Demolition

The first step in the demolition was removal of the ductwork leading to Building 12. This work was started in June 1972 and was completed in February 1973. As ductwork was removed and air supply was reduced, blowers in Building 12 were shut down. When the third blower was shut down, a partition was built in the blower plenum so that blower No. 4 and filter No. 5 could provide ventilation for the building. The position of the partition is shown in Fig. 3 at point No. 8.

A change room was built on the east side of the building, adjacent to the air lock and access door shown in Fig. 3. Here, the workers were suited up, including a fitting and testing of full face masks.

An initial cleaning was done by chemical technicians assisted by janitors, and the final cleaning just before painting was done by janitors and laborers. The painter was kept on duty during the entire period of demolition to paint freshly exposed surfaces. After the walls, ceilings, and partitions had been cleaned with water spray, the floors were wiped with wet rags. Again, the contamination could be reduced only to the levels discussed earlier. Then, water-base paint was applied with a spray gun. After several applications, nearly all exposed areas in the building no longer had any swipe or direct count. However, if any paint peeled off the surface, the direct count would reappear and the area had to be wiped with wet rags and repainted. As expected, all expansion joints still had large amounts of solids that soaked in with water from previous cleaning operations.

At this stage blowers Nos. 1, 2, and 3, were idle. Air was being drawn down the stacks, through the filters in bays 1 through 4 in reverse flow, through the filters in bay 5 in the normal manner, and exhausted through blower No. 4. With this air flow helping to control contamination, removal of stacks 1, 2, and 3 was begun. The roof and walls around the blowers for these three stacks were removed by lifting on a cable wrapped around ceiling beams. The roof was constructed with the beams ending at the middle of the brick wall separating the blower room from the blower plenum. Thus, the beams could be lifted off this dividing wall without exposing the contaminated blower plenum.

After the blower room roof (except for a section over blower No. 4 and another section over the electrical panels) was removed, work was started on removing the stacks. Figure 7 shows a rigger being raised to the top of the first 15.2-m (50-ft) stack to attach a lifting collar. The stacks had a square base that was slipped over a slightly smaller male fitting on the blower to provide the air seal. This joint had been taped and painted to make it air tight. The stack was removed by cutting the tape, cutting some external supports (which were not contaminated), and lifting the stack off the blower with a crane. The bottom of the stack and the opening of the blower were immediately covered with preassembled sheets of plywood. The stack was then placed on a lowboy, the ends were sealed with metal plates, and the stack was wrapped in plastic for hauling to the burial site. Figure 8 shows the blower room after the first three stacks were removed.

The next step was to remove all the filters in banks 1 through 4. As shown in Fig. 9, each bank contained 63 filters, each 0.67 by 0.67 m by 0.22 m (2 ft by 2 ft by 8 in.). The filters were lifted out of the frame and put in plastic bags, carried to the access door of the change room, and slipped into another bag held by two laborers. This outer bag was checked for external contamination so that the package could either be rebagged or could be safely carried through the change room to plywood boxes for burial.

Next, the filter frames were cleaned and painted. Disassembling the filter rack, which had been made by rivetting open-end metal boxes together, required either sawing the frames into pieces or driving a wedge between them so that the rivets would pop loose. The latter method was found to be faster and was used to remove the 252 frames in filter bays 1 through 4. The frames were taken from the building and crated, using the same method that was used for the filters.

The laborers then began disassembling the precipitron frames. These frames were 1.22 m wide, 0.61 m deep, 4.27 m high, and weighed 275 kg. As soon as a frame was unbolted, it was lowered to the floor with a chain hoist, then cleaned, painted, and placed on rollers

to be moved to an access door of the exhaust blower plenum area (Fig. 3). There, a final coat of paint was applied before the frame was rolled through the door onto a large plastic sheeting. The frame was wrapped in plastic, loaded onto a truck, and hauled to the burial site. Figures 10, 11, and 12 give views of various stages of this operation.

Sprinkler pipes and electrical conduit and process lines leading to the oil baths on the precipitron units were removed, cut with hacksaws into 2.5-m lengths, painted, wrapped in plastic, and passed through access doors to be crated for burial.

Similar techniques were used for the large doors that isolated the filter sections. The doors were 1.6-cm (5/8-in.) plywood mounted on a 10-cm channel iron frame. Each bay had two doors 5.2 m wide, one 3.1 m high and the other 4.3 m high.

Except for the filters in bay 5, the building was empty and was considered ready for removal of the interior surfaces of the walls, floor, and ceiling.

The construction details indicated that the contamination of walls and ceiling might be restricted to the first layer of material. As shown in Fig. 13, the roof was made of two layers of wood beams, 5 cm by 20 cm (2 in. by 8 in.), supported by metal I beams. The beams were covered with two layers of gypsum board and a 0.3-cm layer of transite. The final layer was a hot tar and roofing paper application. The ceiling was two layers of gypsum board covered by a fabric called "Walltex." A 1.6-mm-thick metal nailing strip was used to prevent the nails from pulling through the gypsum board when the plenum was operating at its lower air pressure. After the metal strips were pulled from the ceiling, the surface fabric layer, covered with several coats of paint, was easily pulled off leaving a nearly contamination-free surface.

Figure 14 shows construction of the walls and floor. The walls were made of two layers of gypsum board nailed to the inside of the 5-cm by 20-cm studs. Here, too, the gypsum board could be pulled off without contaminating the studs. All exposed surfaces were immediately covered with a coat of paint to seal porous surfaces.

The wall and floor junction consisted of overlapping layers of gypsum board, expansion joint material, and gunnite. This construction had prevented the sill from becoming contaminated; and by removing the expansion joint material along with a strip of the gunnite, the sill was exposed free of contamination. The remaining gunnite was coated with paint until all of the contamination was covered. It remained on the floor for removal with the foundation.

At this time samples of the soil under the floor were taken and analyzed for gross alpha activity. The results, discussed in Sec. VIII., showed that the soil was contaminated in certain areas and would have to be removed to leave a clean site.

Demolition of the plenum could now be completed using power equipment to tear down the roof and walls in a normal manner. The appearance of the intake plenum's interior is shown in Fig. 15, and the appearance of the area that housed the precipitrons and filters is shown in Fig. 16.

In the penthouse area the interior wall covering was removed without spreading contamination to the wall studs. The floor, however, was built of 5-cm by 10-cm tongue and groove boards, and the cracks between the boards were filled with contaminated dirt, which could not be fixed, even with several coats of paint. Therefore, all the floor boards were pried loose and painted individually to fix the contamination. These interior floor boards and the gypsum wallboard were packed in plywood boxes, then banded and sealed and hauled to the burial site. The interior, after removal of floor and interior surface of the walls of the penthouse, is shown in Fig. 17.

The external siding was made of paperboard nailed to the 5-cm by 20-cm studs covered with corrugated asbestos siding. The asbestos siding was removed, monitored for alpha contamination, and hauled to the LASL waste disposal site. Figure 18 shows the building after the siding was removed. Because no alpha contamination was found on the siding, it was hauled to the disposal site in an open truck.

After the exhaust plenum, blower plenum, precipitron area, and the penthouse area had been stripped,

cleaned, and painted as discussed earlier, a survey for alpha contamination showed that all contamination was fixed, except for the soil under the floor and in the expansion joints in the concrete floor.

The steel columns that held the ten large doors could not be dismantled without cutting torches. Because of the fire danger from wooden construction in the area it was decided to leave the steel standing and tear down the building around the steel. After all combustible material was removed, the steel was cut up and hauled to the disposal site. The removal of the steel is discussed later in this section.

The interior was stripped and cleaned as much as possible. The next step was to shut down the last blower and to remove the last bank of filters. Because this would leave the building without any ventilation, a 300-m³/min blower and HEPA filter were installed.

While blower No. 4 was still running, and before the new blower was started, the filters were coated with water-base spray paint to fix the dust and contamination. Just as the filters began to plug, the large blower was shut off and the 300-m³/min blower was started.

The filters and frames were then removed, using the same technique as for the others. After bay 5 was stripped and cleaned, the building was surveyed again for alpha contamination. When all loose contamination and detachable items were removed and all areas were painted at least three times to cover impregnated contamination, the decision was made that the remainder of the building could be safely torn down and loaded onto trucks with equipment working from the outside.

Because no contamination could be detected on the remaining portions of the walls, it was decided to pull the penthouse over with a cable as if it were a normal building being razed. This was done, exposing the steel beam door supports. Figures 19 and 20 show the building with most of the penthouse gone. As portions were pulled down, the long boards were cut into 2.5-m sections with chain saws. The pieces were checked for contamination and then loaded into a dump truck fitted with plywood sides, canvas top, and rear flap. Only rarely was

any contamination found, and when it was the area was immediately painted.

The remainder of the walls and ceiling of the blower room, which never had been contaminated, were broken apart and loaded onto a truck with a payloader. The concrete foundations were broken loose with a bulldozer and loaded onto the dump truck.

After the work on the penthouse and blower room was completed, work was started on the intake plenum. The roof was pulled down with cables, and the debris was hand-loaded into the covered truck. Then the walls were pushed over, dismantled, and loaded. Figure 21 shows this area after one of the walls was pushed over. When this work was completed, the building was reduced to the brick and steel remaining in the precipitron area and the floor of the intake plenum area.

The next stage was to tear out the intake plenum floor with a payloader. The foundation was extensive, as shown in Fig. 22. The concrete at the point where the external foundation intersects with the internal foundations was often 46 cm thick. The foundation was 1.52 m deep, and because some of the soil inside was contaminated, the decision was made to have the equipment dig deep enough to go beneath the foundation and to load foundation, soil, and floor at the same time. Figure 23 shows the equipment in the process of removing the plenum floor area. When that was completed the building was reduced to the steel, brick and concrete shown in Fig. 24.

An attempt was made to pull some of the steel down with a cable and in the process to break some bolts and rivets so that the individual beams could be loaded onto the truck. Unfortunately, the construction was such that when the bulldozer pulled on a piece of steel at the end of the building, the whole steel assembly toppled over and became the tangled mess shown in Fig. 25. The steel then had to be cut apart with cutting torches and loaded onto an open dump truck with a crane. Figures 26, 27, and 28 show various stages of this operation.

After the steel was cleared away, only the concrete floor and foundations in the precipitron and filter remained (Fig. 28). The only contaminated areas on the floor

slabs were the edges that had been in contact with the expansion joints, and these areas were immediately painted. A bulldozer (Fig. 29) was used to lift the floor slabs and push them to an area where the payloader could load them onto a dump truck. Then the bulldozer was used to loosen and break the foundation into pieces small enough to load. Most of the foundation was 15 to 20 cm thick and 1.5 m deep. However, one piece of the foundation was nearly 75 cm wide, 1.5 m deep, and 30 m long. Efforts to break this foundation into small chunks with the bulldozer proved fruitless. Therefore, this 30-m piece of foundation had to be weakened by drilling a series of holes as a perforation line. Part of this perforation line is shown in Fig. 30. The bulldozer was then able to break this foundation into pieces small enough to be lifted onto the truck. Figure 31 shows the removal of the last concrete and dirt from the site.

The final task was to remove the drain pipe that led from the precipitron and filter area to a tile field. The tile field had been removed several years earlier, but the plugged drain line remained in place. Workers engaged in removing the drain line are shown in Fig. 32. Although this cast iron drain line had been embedded in the soil for nearly 30 yr, corrosion had penetrated less than 0.16 cm ($< 1/16$ in.).

After the drain line was removed, the trench and the area that had been occupied by the building were surveyed for alpha contamination. When no alpha contamination was detected, soil samples were taken for analyses, the area was backfilled with dirt until the original ground contour was restored, and native grasses were planted as a ground cover. Figure 33 shows the area after completion of the backfilling operation.

The demolition work was started in February and completed in July 1973, at a total cost of approximately \$160 000. Craftsmen employed on this project were riggers, painters, laborers, equipment operators, truck drivers, carpenters, and electricians.

V. HEALTH PHYSICS

Personnel assigned to do the demolition were inexperienced in dealing with plutonium contamination. However, they were provided with formal health physics instruction and with day-to-day instructions from the plutonium plant supervisor and from health physics technicians who were present during all phases of the project. All workers also participated in a full face respirator fitting and testing program. Full face respirators equipped with high-efficiency particulate filters were the standard respiratory protection during all phases of demolition involving loose contamination. During prior decontamination work in 1960, supplied air suits were used.

Demolition workers were provided protective (anti-contamination) clothing for work in the area. For work inside the building, workers were double-suited with coveralls, booties, a cap and hood, gloves, and underwear (Fig. 34). Disposable paper coveralls, hoods, and plastic booties were used for outerwear. The outer garments were overlapped and taped together, and openings in the coveralls were taped shut. This clothing provided adequate protection against worker contamination during the demolition, and no personnel decontamination beyond normal showering and washing procedures was required.

Air in the working area was sampled by drawing it through HV-70 filter paper at the nominal rate of $0.56 \text{ m}^3/\text{min}$. The paper was removed and counted daily for alpha activity to provide a record of the workers' exposure to air contamination. On four occasions the air-borne plutonium concentration exceeded $2000 \times 10^{-12} \text{ } \mu\text{Ci}/\text{m}^3$, but during most of the remaining work days the concentration generally ranged from 50 to $150 \times 10^{-12} \text{ } \mu\text{Ci}/\text{m}^3$ with some as low as $2 \times 10^{-12} \text{ } \mu\text{Ci}/\text{m}^3$.

All personnel working on the project were provided with monthly beta-gamma and neutron film badges to record external radiation exposures. The highest monthly recorded exposure was 40 mrem. All workers were surveyed for alpha contamination before leaving the area, and nose swipes were collected after work requiring

respiratory protective equipment. The frequency of these monitoring practices varied somewhat with the assigned task and level of contamination involved. A few cases of hand contamination occurred; however, all were decontaminated by normal showering and washing methods. Of 1195 nose swipes collected only four were > 10 dis/min alpha; of these 85 dis/min was the highest single result. Workers submitted urine samples for plutonium analysis at the beginning and completion of the job. Most workers were given plutonium chest counts at job completion. No measurable plutonium body or lung burdens were indicated by the results of the urinalysis and chest counting programs. One minor injury occurred during the job. The wound, caused by a nail puncture, was monitored by alpha and x-ray monitoring techniques and found to be free of plutonium contamination.

VI. WASTE MANAGEMENT

Waste materials were packaged in different ways depending on size and contamination level to make transport and disposal safe. Small items and highly contaminated larger items that could be reduced in size were placed in plastic-lined 0.56-m^3 cardboard boxes. The bags were sealed with tape to prevent leaks during disposal. Approximately 1320 cardboard boxes were filled with waste and buried at LASL's solid radioactive waste disposal site, about 9 km from the demolition site. The location of this site is shown in Fig. 33. Larger items, such as filters, filter frames, gypsum board pieces, and metal trim, were wrapped in plastic and placed in 69 plastic-lined plywood crates (1.2 by 1.2 by 2.4 m) for burial at the disposal site. In addition to the boxed and crated waste, approximately 1200 m^3 of contaminated transite, doors, lumber, pipes, roofing materials, and metals were taken to the disposal site in covered dump trucks. Fixing the contamination on large items with several coats of paint allowed for handling, transport, and disposal without vehicle or personnel contamination problems. In addition to the waste already mentioned, approximately 400 m^3 of concrete, dirt, and large metal items were buried in a disposal site located at TA-21, 300 m from the building site.

All waste packages and unpackaged items were monitored for plutonium contamination with portable alpha survey instruments. The waste was buried as nonretrievable, < 10 nCi/g plutonium waste. The wastes that contained > 10 nCi/g plutonium had been placed in retrievable storage during decontamination, before actual demolition.

Trucks, loaders, and bulldozers used to load or transport contaminated materials were monitored during the job and decontaminated as necessary. The equipment did not become highly contaminated, and washing with cold water was sufficient to reduce contamination levels to less than 100 dis/min per 60 cm^2 .

During the 109 days required for the demolition work and site clean-up, a total of 235 man-days of health physics technician effort were required for personnel and miscellaneous monitoring.

VII. ENVIRONMENTAL AIR MONITORING

The Los Alamos Scientific Laboratory Environmental Studies Group monitored the environmental impact of the demolition operation with its routine air sampling network and a special on-site sampling program. The routine air sampling network, consisting of 36 sampling stations was supplemented with two additional stations to more adequately encircle the demolition site. The positioning of the supplemental samplers was limited somewhat by availability of electrical power and access to the equipment. The location of these sampling stations (with the exception of the Santa Fe, Espanola, and Pojoaque stations) and of the demolition site are shown in Fig. 35.

The samples drew air through a 78-mm Microsorban filter with an efficiency of about 99.8% for $0.3\text{-}\mu\text{m}$ dioctyl phthalate (DOP) particles (a standard test aerosol for determining filter efficiency) at either 70 l/min or 200 l/min . The two different rates were due to replacing the 70-l/min pumps with higher capacity pumps that require less maintenance.

The 38 samples were collected weekly. This schedule was not intended to provide an early detection of a plutonium release but to help document the magnitude of an accidental release. Meteorological data were available

for TA-21 during the entire operation and could have been used if a high gross alpha concentration had been detected at any of the sampling stations. Because no concentration of any significance was detected, it was not necessary to use the data to determine the pollution source.

The samples were handled routinely; they were counted after a 1-day decay period and then recounted after approximately a 10-day decay period to allow for the decay of natural radon and thoron daughters. During the demolition both measurements were observed and compared to background levels to detect any abnormal concentrations. An attempt was made to compare these 10-day measurement data to the corresponding data for 17 weeks of 1972 to eliminate seasonal background variations. However, the data for those weeks in 1972 were influenced by fallout from a Chinese Nuclear Test and no meaningful comparison was possible. Instead, the data were compared to the 1972 averages. These data are presented in Table II and indicate that if plutonium was released to the environment during demolition, it was minimal and had no detectable impact on the overall gross alpha background levels in the area.

Air monitoring in the immediate vicinity of the structure was added to provide an early detection of a release of radioactivity. If such a release had been detected the operation would have been curtailed until more protective demolition measures could be used. These samples (location of samplers shown in Fig. 36) were collected daily. Because of mechanical failures, a variety of sampling devices and rates were used. On April 4, 1973, at the start of the sampling operation, the network consisted of four Staplex "Hi-Volume" samplers. They sampled through 76-mm-diam Microsorban paper (similar to the filter media for the weekly samples) at a rate of approximately $0.37 \text{ m}^3/\text{min}$. Two of the samplers were located near buildings and used line power; the other two were driven by gasoline-powered generators.

By the end of April three of the samplers had been changed to use 100-mm Microsorban filters to increase the flow rate and reduce pump heating. The flow increased to approximately $0.52 \text{ m}^3/\text{min}$. These samplers were located, as shown in Fig. 36, so that they could be operated on line power and were used throughout the remain-

der of the sampling period. The fourth sampling station was abandoned because the others would give adequate coverage. The samplers were not centered around the building but instead, around the center of the demolition activity, where releases of contamination were more likely to occur.

The filters were first counted by Health Physics personnel within an hour after collection for early detection of a release. Two weeks later, after allowing for decay, they were counted by Environmental Studies personnel. The average and maximum gross alpha concentration values for the second measurement are compared in Table III to AEC Manual Chapter 0524, Concentration Guides for Uncontrolled Areas. All of the gross alpha activity was assumed to be insoluble ^{239}Pu for comparison to applicable concentration guides. The highest 24-h concentration at any on-site sampler ($8.7 \times 10^{-13} \text{ } \mu\text{Ci}/\text{m}^3$)

TABLE II
GENERAL SURVEILLANCE AIR MONITORING RESULTS
Average Gross Alpha Concentrations^a
($\times 10^{-8} \text{ } \mu\text{Ci}/\text{m}^3$)

Station Number	Coordinates	1972 4/5 thru 7/26	1972	1973 4/5 thru 8/1
1	N220 E220	1.8 ± 2.2	2.0 ± 0.6	1.2 ± 0.6
2	N220 E300	2.3 ± 2.6	1.9 ± 0.6	0.8 ± 0.4
3	N200 E380	1.7 ± 2.4	1.7 ± 0.6	1.4 ± 1.0
4	N180 E130	1.5 ± 1.6	1.6 ± 0.4	1.0 ± 0.6
5	N170 E 20	2.2 ± 2.8	1.6 ± 0.6	1.2 ± 0.8
6	N160 E 60	2.2 ± 2.6	1.5 ± 0.6	1.3 ± 1.0
7	N150 E490	1.7 ± 1.8	1.7 ± 0.4	1.4 ± 0.8
8	N140 E130	1.5 ± 2.2	1.7 ± 0.6	1.3 ± 1.0
9	N130 E 20	1.8 ± 2.2	1.6 ± 0.6	1.5 ± 0.8
10	N110 E 90	2.0 ± 2.6	1.6 ± 0.6	1.3 ± 0.6
11	S 90 E390	1.8 ± 2.2	1.6 ± 0.6	1.4 ± 0.6
12	S210 E370	1.5 ± 2.4	1.3 ± 0.6	0.9 ± 0.6
13	S270 E190	1.0 ± 1.0	1.5 ± 0.4	1.3 ± 0.8
14	-	3.3 ± 2.8	2.1 ± 1.0	1.5 ± 1.0
15	-	-	-	1.2 ± 1.2
16	-	3.3 ± 4.2	2.0 ± 0.8	0.8 ± 1.0
<u>Perimeter</u>				
17	N110 E160	2.7 ± 3.6	1.9 ± 0.8	0.8 ± 0.6
18	N110 E260	1.3 ± 2.0	1.6 ± 0.8	1.0 ± 0.8
19	N100 E 20	1.9 ± 2.4	1.5 ± 0.6	1.4 ± 1.2
20	N100 E110	1.8 ± 2.8	1.4 ± 0.6	1.0 ± 0.6
21	N 80 E 10	1.7 ± 2.8	1.5 ± 0.6	1.2 ± 0.6
22	N 30 E310	1.8 ± 2.8	1.5 ± 0.6	0.8 ± 0.4
23	S 80 90	2.2 ± 2.4	1.5 ± 0.6	1.1 ± 0.8
24	S100 E 40	1.6 ± 1.8	1.5 ± 0.6	0.8 ± 0.6
25	S100 E300	2.1 ± 2.2	1.6 ± 0.6	1.1 ± 0.6
26	S270 E200	1.9 ± 2.0	-	1.3 ± 0.8
<u>On-Site</u>				
27	N 90 E170	1.6 ± 1.8	1.3 ± 0.4	0.8 ± 0.4
28	N 60 E180	3.0 ± 4.4	2.2 ± 0.8	1.0 ± 0.4
29	N 40 E 20	1.9 ± 3.2	1.5 ± 0.6	1.0 ± 0.6
30	N 20 E170	2.6 ± 4.2	1.6 ± 0.4	1.0 ± 0.6
31	S 30 W 10	1.3 ± 2.2	1.1 ± 0.4	1.1 ± 0.8
32	S 30 E190	1.8 ± 2.0	1.5 ± 0.4	1.7 ± 1.2
33	S 50 E160	1.5 ± 1.4	1.1 ± 0.4	0.8 ± 0.4
34	S 60 E 10	1.1 ± 1.4	1.2 ± 0.4	1.1 ± 0.8
35	S 70 E 80	1.5 ± 1.8	1.3 ± 0.4	0.8 ± 0.6
36	S250 E230	3.3 ± 5.4	1.9 ± 1.2	1.1 ± 1.0
37	N 20 E110	-	-	1.1 ± 0.8
38	N 70 E115	-	-	1.1 ± 1.0

^aAverage (± 2 standard deviations)

TABLE III
ON-SITE (TA-21) GROSS ALPHA CONCENTRATIONS IN AIR

Sampling Period	Average ^a (± 2 S.D.) (10^{-15} μ Ci/ml)	Percent of CG ^b for Average	Maximum ^c (± 2 S.D.) (10^{-15} μ Ci/ml)	Percent of CG ^b for Maximum
4/4 -4/9/73	4(\pm 4)	0.4	8(\pm 1)	0.8
4/10 -4/16/73	11(\pm 49)	1.1	114(\pm 5)	11.4
4/17 -4/23/73	2(\pm 3)	0.2	6(\pm 1)	0.6
4/24 -4/30/73	11(\pm 4)	1.1	78(\pm 9)	7.8
5/1 -5/7/73	3(\pm 8)	0.3	17(\pm 8)	1.7
5/8 -5/14/73	8(\pm 24)	0.8	42(\pm 15)	4.2
5/15 -5/21/73	73(\pm 418)	7.3	632(\pm 243)	63.2
5/22 -5/28/73	4(\pm 15)	0.4	28(\pm 16)	2.8
5/29 -6/4/73	2(\pm 4)	0.2	6(\pm 3)	0.6
6/5 -6/11/73	3(\pm 7)	0.3	15(\pm 8)	1.5
6/12 -6/18/73	24(\pm 96)	2.4	112(\pm 55)	11.2
6/19 -6/25/73	39(\pm 83)	3.9	166(\pm 80)	16.6
6/26 -7/2/73	98(\pm 188)	9.8	278(\pm 111)	27.8
7/3 -7/9/73	110(\pm 490)	11.0	869(\pm 347)	86.9
7/10 -7/16/73	10(\pm 23)	1.0	38(\pm 15)	3.8
7/17 -7/23/73	2(\pm 4)	0.2	7(\pm 3)	0.7
7/24 -7/30/73	1(\pm 3)	0.1	6(\pm 2)	0.6
7/30 -8/2/73	1(\pm 1)	0.1	2(\pm 1)	0.2

^a Arithmetic Mean for all 24-h samples for particular sampling period (± 2 Standard Deviations).

^b Concentration Guide for insoluble ²³⁹Pu for uncontrolled areas, AEC Manual Chapter 0524.

^c Maximum concentration of any single 24-h sample during the sampling period (± 2 Stand. Dev.).

on July 5) was 87% of the (1×10^{-12} μ Ci/ml) concentration guide for insoluble ²³⁹Pu in controlled areas.

Air exhausted by the ventilation blower was sampled by drawing it through HV-70 filter paper at the nominal rate of 0.56 m³/min. The filter papers were measured daily for gross alpha activity. Data indicated that 1371 μ Ci of plutonium were released through the blower between February and May 1973.

VIII. SOIL SAMPLING

As was mentioned in Sec. IV., water from clean-up operations escaped the building through expansion joints in the concrete floor. For this reason, the concrete was broken and surface and core samples of dirt were collected at suspect locations to determine the magnitude and depth of contamination. The surface samples were collected with a spoon from the top centimeter of soil, and

the core samples were collected by driving a 2.54-cm-diam polyvinyl chloride (PVC) pipe into the soil with a hammer. The sample locations and the gross alpha concentrations at those locations are shown in Fig. 37 and Table IV, respectively. The data confirmed expectations that some soil underneath the building would be contaminated.

After the building and approximately 30 cm of soil were removed, an attempt was made to survey the remaining 2-m depression with a low-energy x-ray detector. The results of the survey were meaningless, however, because the instrument readings were influenced by radioactive materials stored in a nearby building. Therefore, soil core samples were collected at the locations shown in Fig. 38. Samples collected at points 4, 5, and 6 (near the centerline of the building) were divided into the listed segments to determine variation in

TABLE IV

GROSS ALPHA CONCENTRATION OF SOIL SAMPLES COLLECTED FROM UNDER INTAKE PLENUM

Surface Samples		Core Samples		
Sample Location ^a	Gross alpha Concentration (pCi/g)	Sample Location ^a	Depth from Surface (cm)	Gross alpha Concentration (pCi/g)
①	67	①	0 - 2.5	36
②	21	"	6.4 - 8.9	9
③	17	"	12.7 - 15.2	6
④	563	②	0 - 2.5	10
⑤	207	"	6.4 - 8.9	1
⑥	124	③	0 - 2.5	108 000
⑦	4	"	6.4 - 8.9	4 653
⑧	311	"	12.7 - 15.2	3 722
		"	25.4 - 27.9	446
		④	0 - 2.5	30
		"	6.4 - 8.9	4
		⑤	0 - 2.5	33
		"	6.4 - 8.9	10
		"	12.7 - 15.2	21
		"	20.3 - 22.9	20

^a See Figure 37 for location.

contamination with depth. Samples from the other locations were analyzed as single samples. Runoff from a rainshower the previous night that had formed a puddle at the northeast side of the depression was also sampled; its gross alpha concentration was less than the minimum detection limit of $4 \times 10^{-8} \mu\text{Ci/l}$.

To arrive at a quick estimate of contamination levels and also minimize the number of plutonium analyses, gross alpha measurements were made on all the samples by leaching the samples with acid and analyzing the leachate. The gross alpha concentrations were used to select samples for plutonium analyses that would include the maximum and minimum gross alpha concentrations and several concentrations within the range. The plutonium data are shown in Table V.

TABLE V
PLUTONIUM IN SOIL SAMPLES TAKEN FROM CLEARED SITE

Sampling Station ^a	Depth from Surface (cm)	²³⁸ Pu (pCi/g)	²³⁹ Pu (pCi/g)
1	0 - 20.9	0.3 ± 0.08	25.7 ± 1.1
2	0 - 14.0	-	-
3	0 - 22.2	-	-
4	0 - 2.5	0.4 ± 0.07	28.9 ± 1.2
	2.5- 7.6	-	-
	7.6- 22.8	-	-
5	0 - 2.5	-	-
	2.5- 7.6	0.6 ± 0.1	42.5 ± 1.5
	7.6- 12.7	0.7 ± 0.1	70.0 ± 2.5
	12.7- 33.0	0.22 ± 0.01	4.3 ± 0.2
6	0 - 2.5	-	-
	2.5- 7.6	-	-
	7.6- 15.2	0.3 ± 0.04	30.0 ± 1.1
7	0 - 16.5	-	-
8	0 - 16.5	-	-
9	0 - 17.8	0.4 ± 0.08	50.7 ± 2.3
	Fill dirt	0.03 ± 0.01	1.3 ± 0.1

^a See Fig. 38 for location.

IX. FINAL SITE CONDITION

The depression was filled with soil from a previous excavation of a trench approximately 300 m due east of the Building 12 site. A composite sample of this fill dirt contained $0.03 \pm 0.01 \text{ pCi/g } ^{238}\text{Pu}$ and $1.3 \pm 0.1 \text{ pCi/g } ^{239}\text{Pu}$. The site was graded to its original natural contour, and the area was seeded with native grasses. The site, after grading and seeding, is shown in Fig. 33.

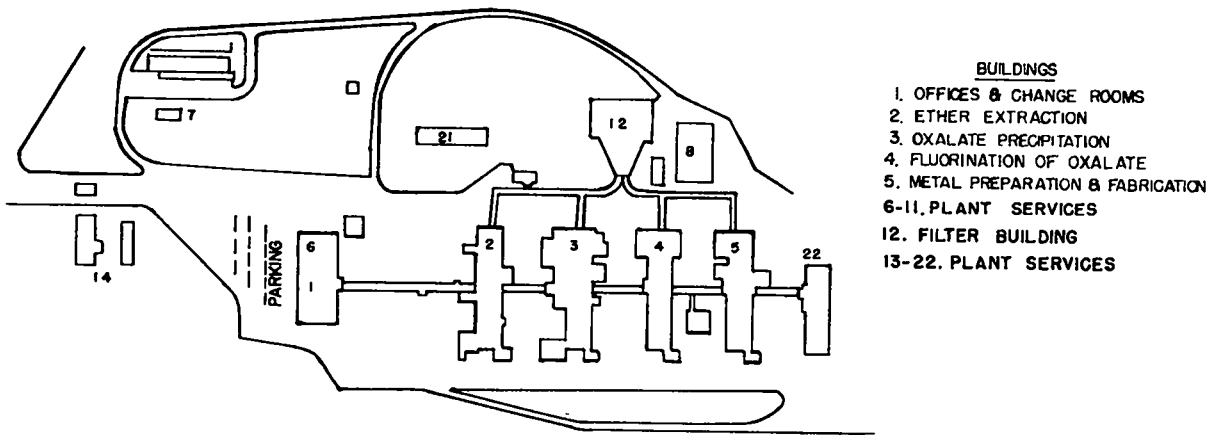

Fig. 1. General layout of DP Site West.

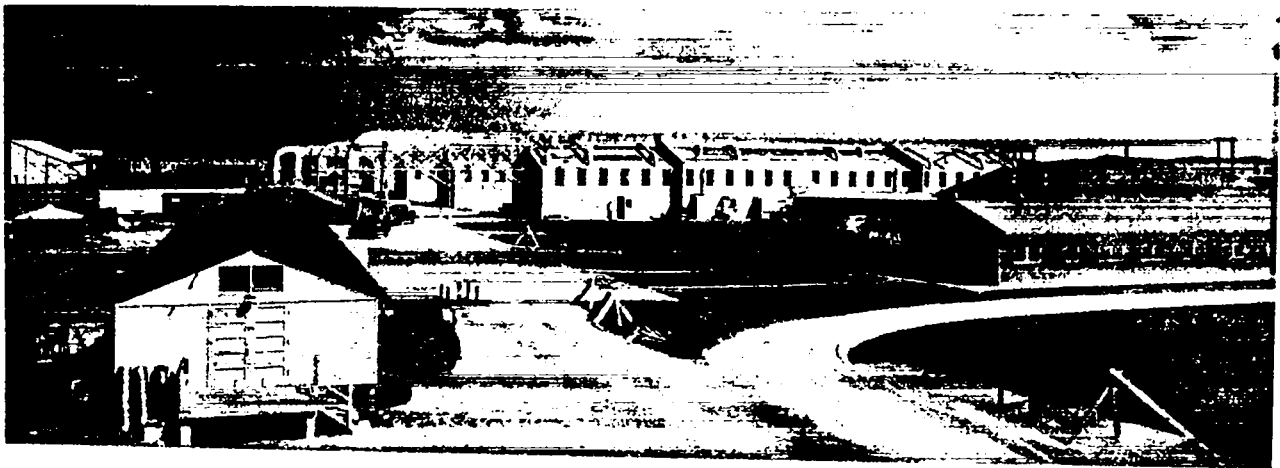

Fig. 2. View of plutonium processing facility.

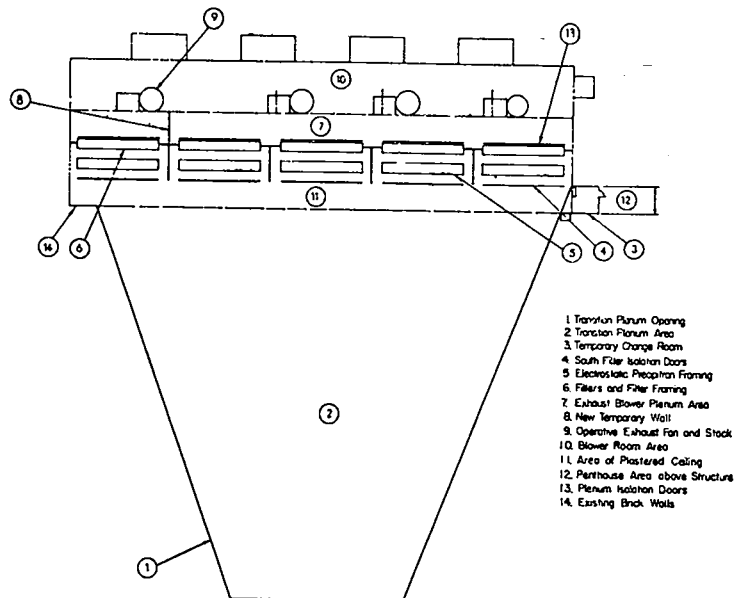

Fig. 3. Floor Plan of Building DP-12.

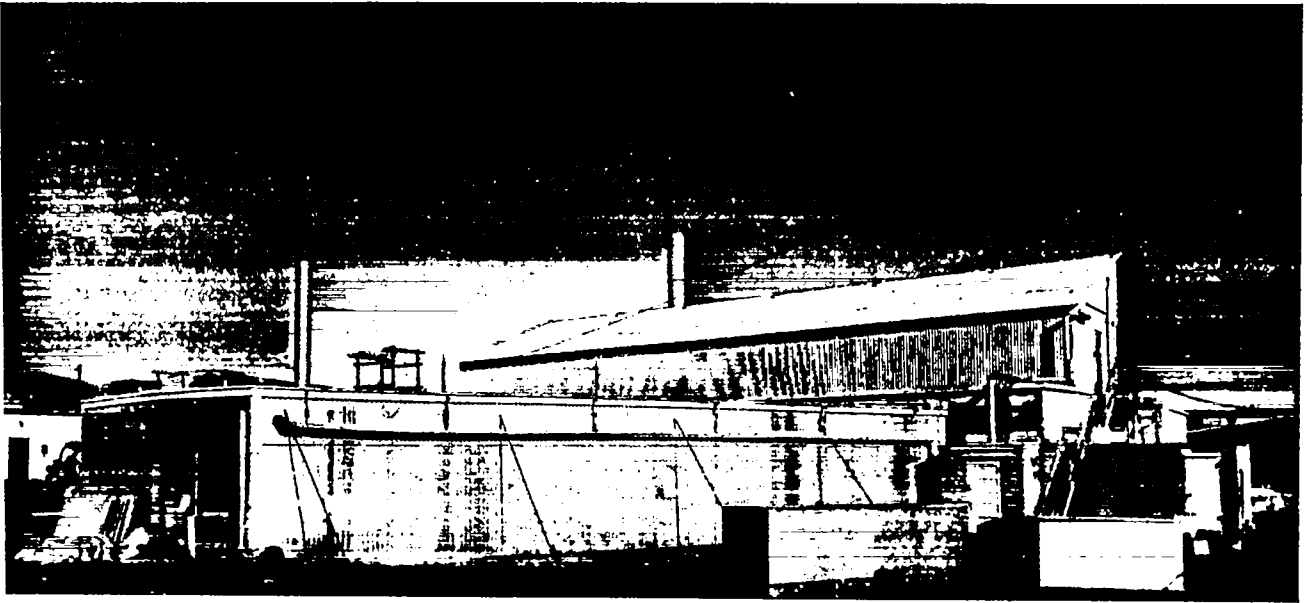

Fig. 4. Side view of Building 12.

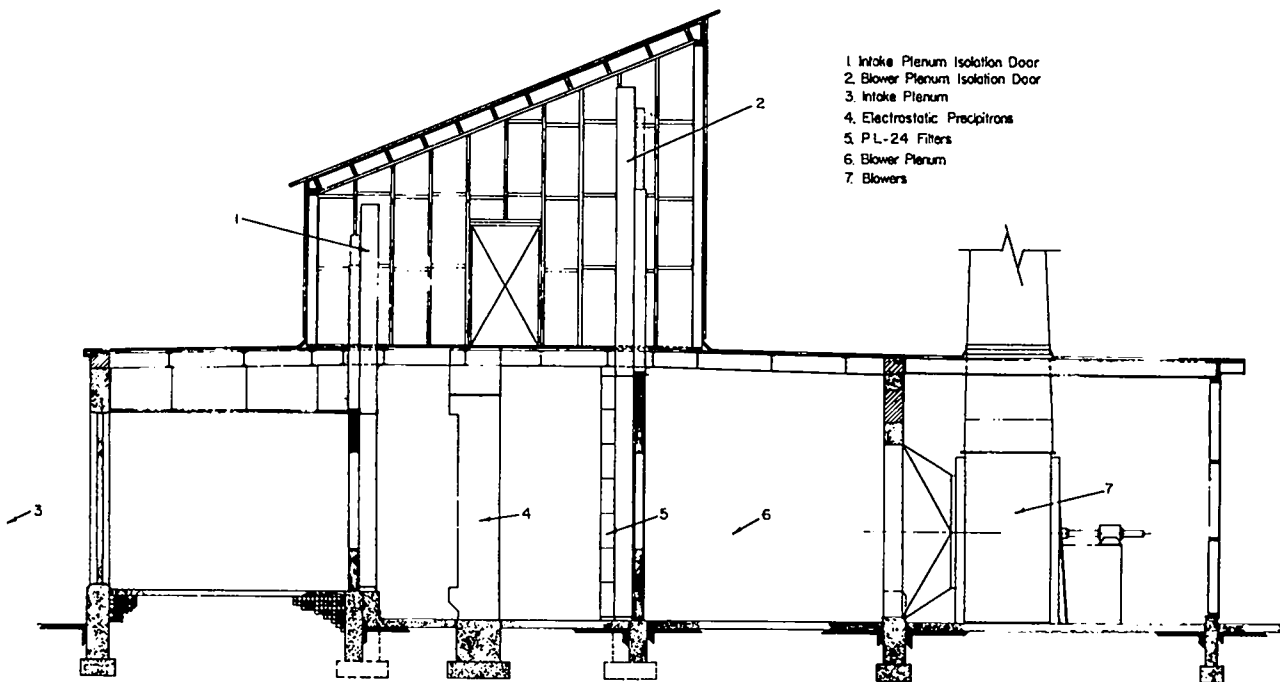

Fig. 5. Side view of blower and filter area.

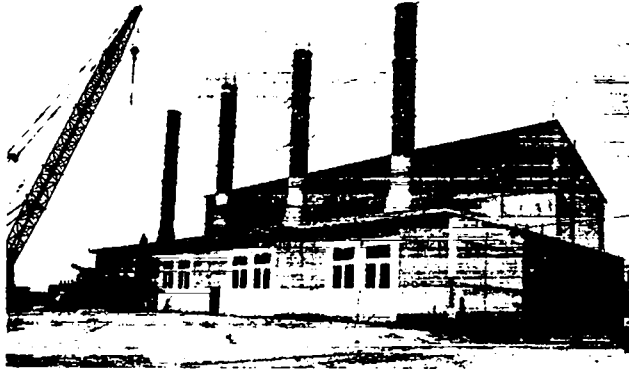

Fig. 6. Front view of Building 12.

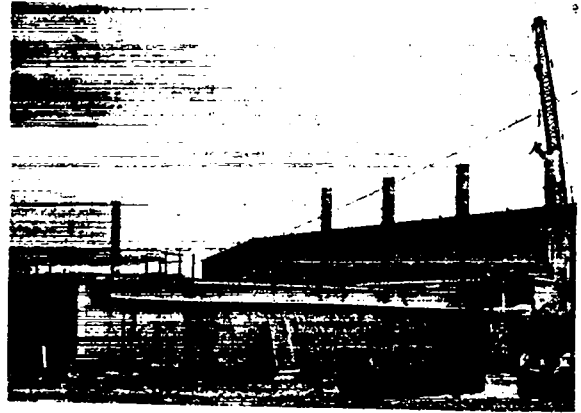

Fig. 7. Preparing to remove stack No. 1.

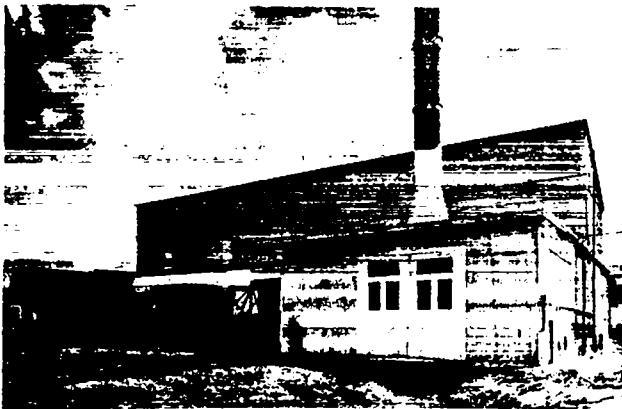

Fig. 8. Blower room after removal of stacks Nos. 1, 2, and 3.



Fig. 9. View of filter banks in 1945.



Fig. 10. Precipitron frame being rolled onto plastic sheeting.



Fig. 11. Precipitron frame being wrapped in plastic, ready for loading.



Fig. 12. Precipitron frame ready for hauling to disposal site.

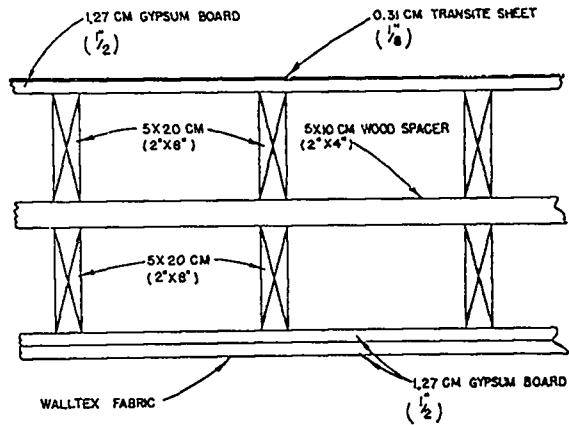

Fig. 13. Details of roof construction.

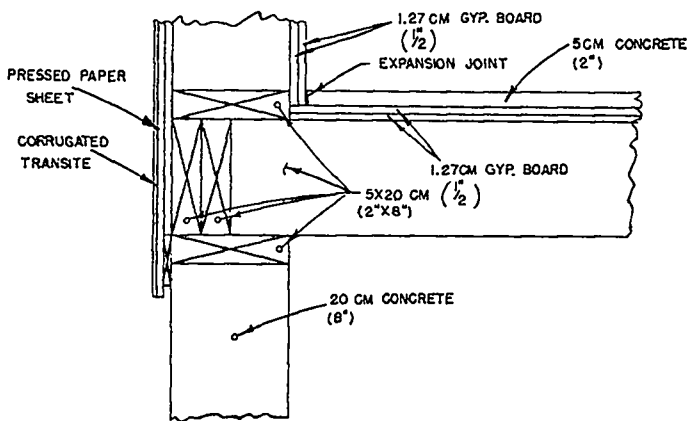

Fig. 14. Details of floor and wall construction.



Fig. 15. Intake plenum after stripping and painting.



Fig. 16. Precipitron and filter area after stripping and painting.

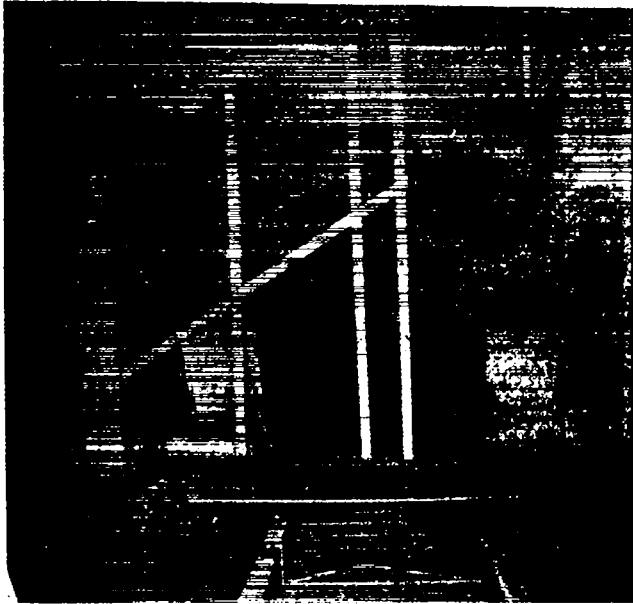

Fig. 17. Interior of penthouse area after stripping and painting.

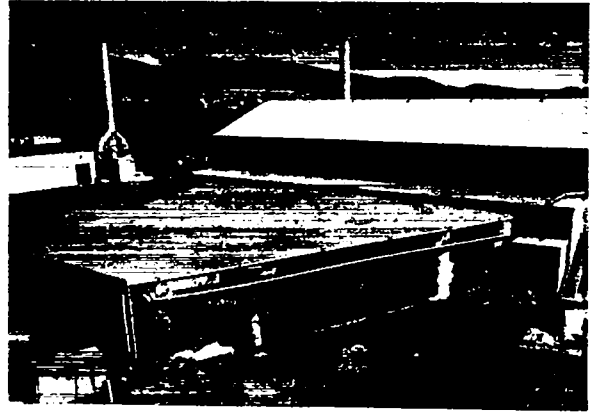

Fig. 18. Building 12 after corrugated siding had been removed from intake plenum wall.



Fig. 19. Ground-level view of penthouse area after removal of most of the walls and roof.

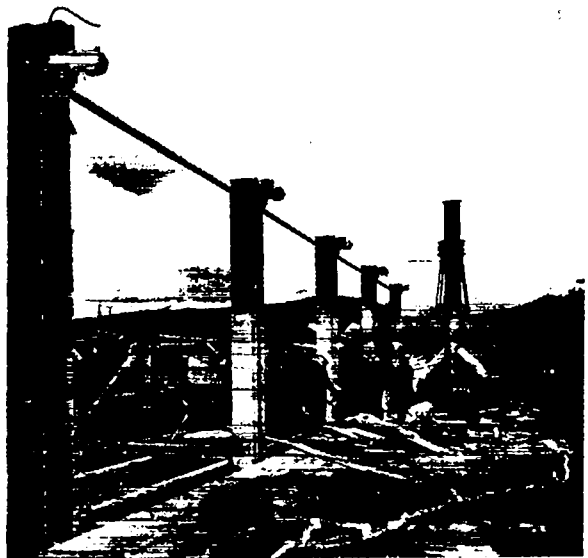

Fig. 20. Roof-level view of penthouse area, after removal of most of the walls and roof.

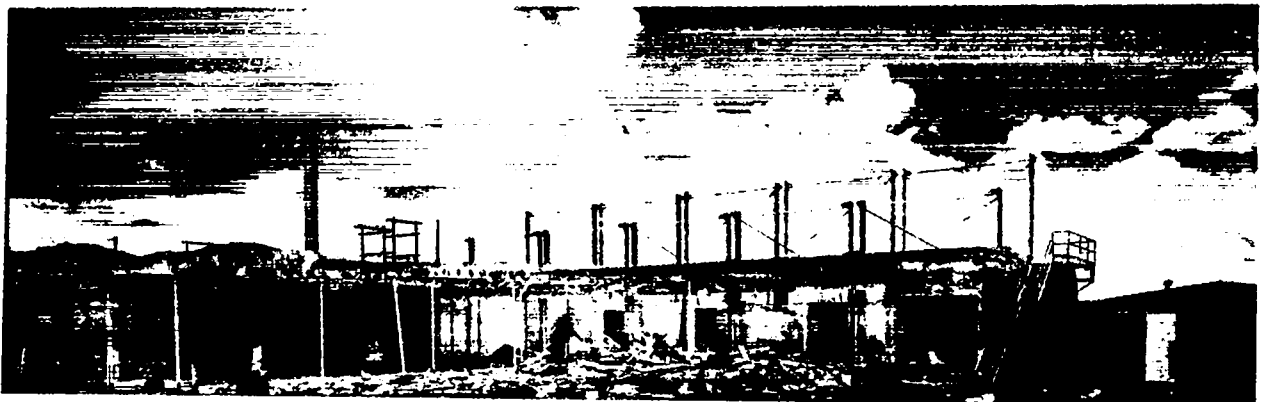

Fig. 21. Intake plenum after east wall was pulled down.

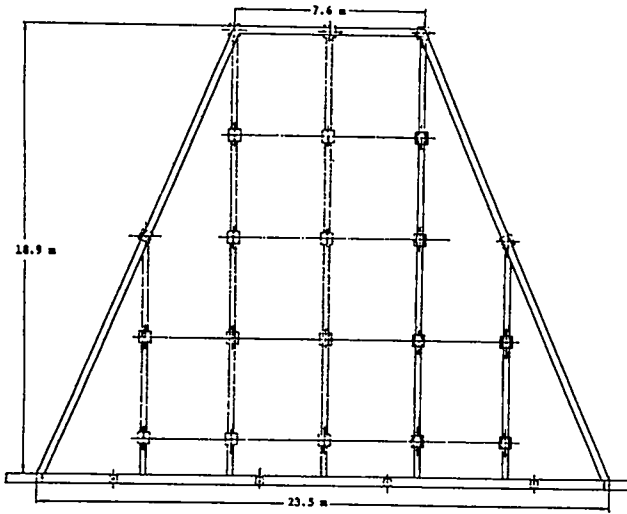

Fig. 22. Foundation for intake plenum.

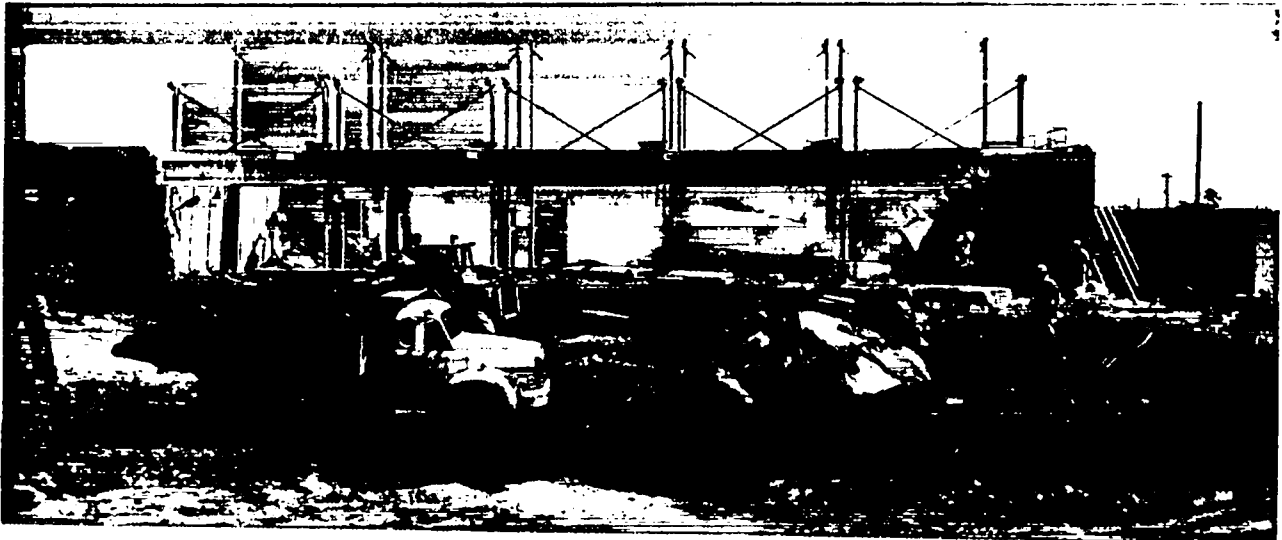

Fig. 23. Removal of intake plenum floor.



Fig. 24. Precipitron and filter area after blower room and intake plenum were removed.

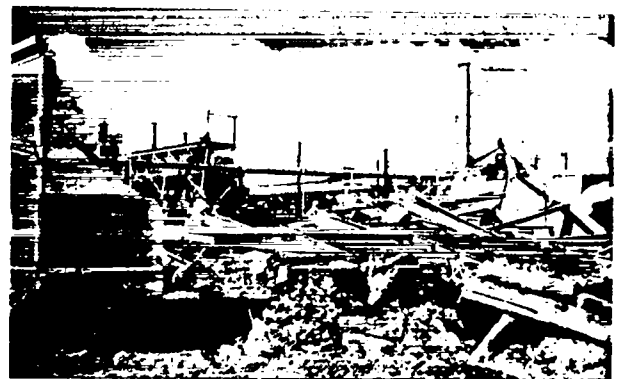

Fig. 25. Appearance of structural steel after attempt to pull down individual pieces.

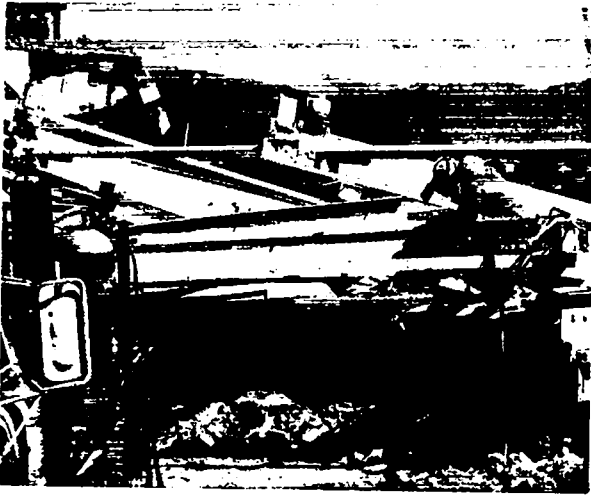

Fig. 26. Cutting steel beams with welding torch.



Fig. 27. Loading steel beams onto truck for disposal.

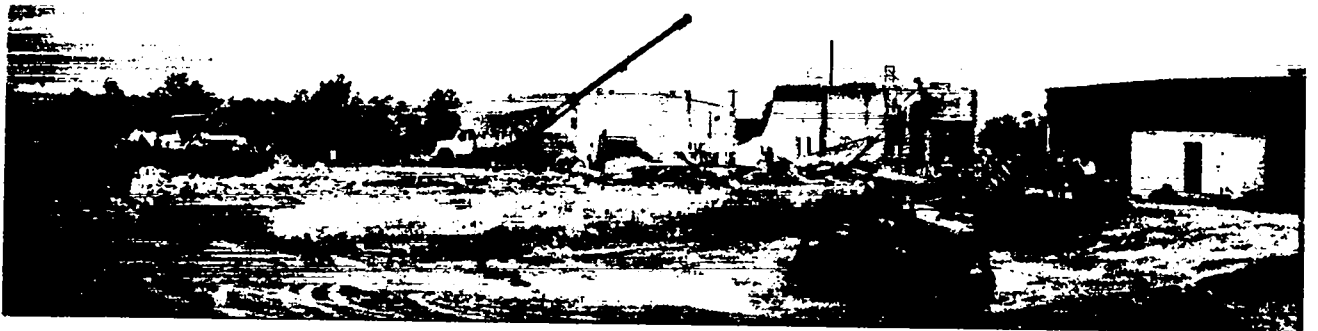

Fig. 28. Precipitron area after most of the steel had been removed.



Fig. 29. Bulldozer removing concrete floor in precipitron area.



Fig. 30. Part of concrete foundation.



Fig. 31. Removing the last concrete and dirt.



Fig. 32. Removing drain line.

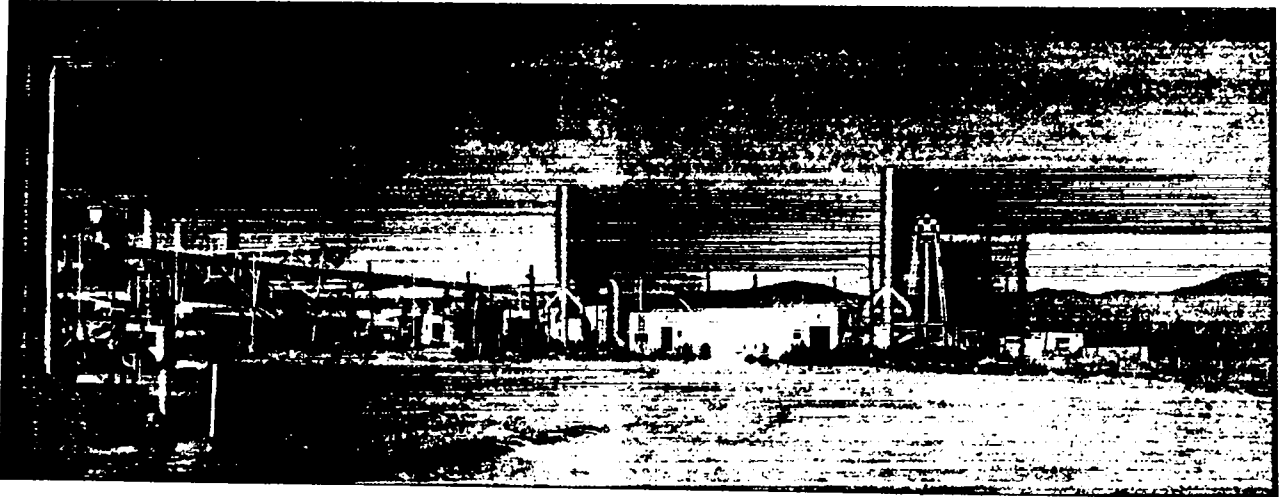

Fig. 33. View of site after completion of demolition.



Fig. 34. Worker suited for demolition work.

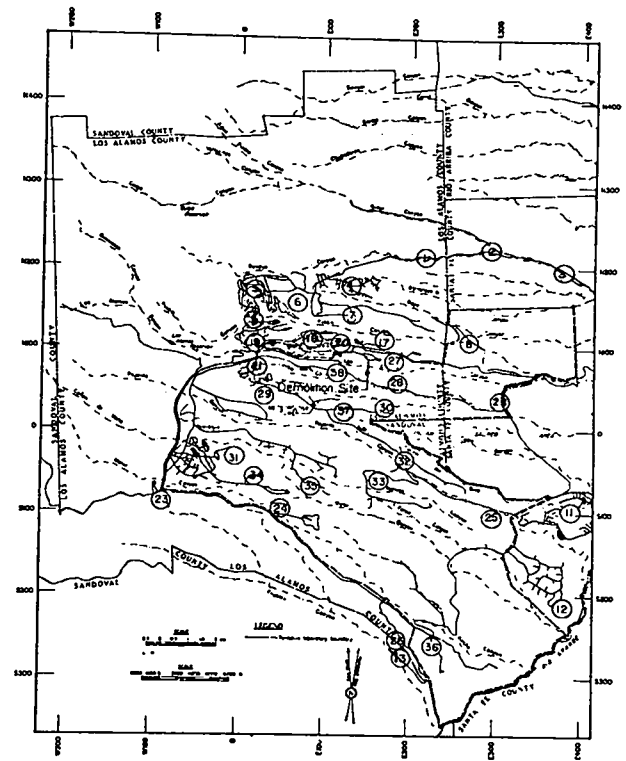

Fig. 35. Location of demolition site and air sampling stations.

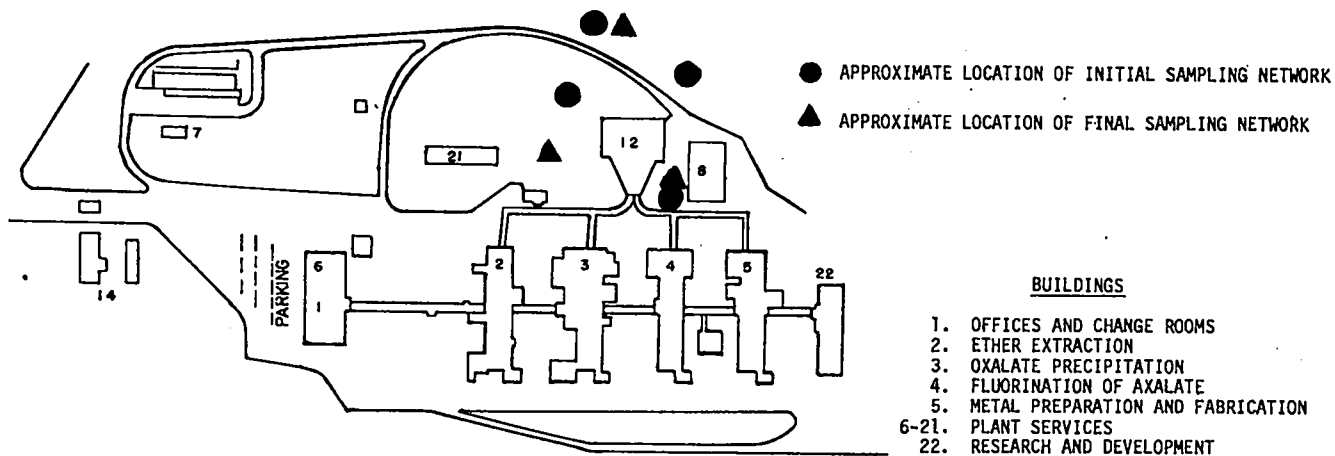

Fig. 36. On-site (TA-21) air sampler locations.

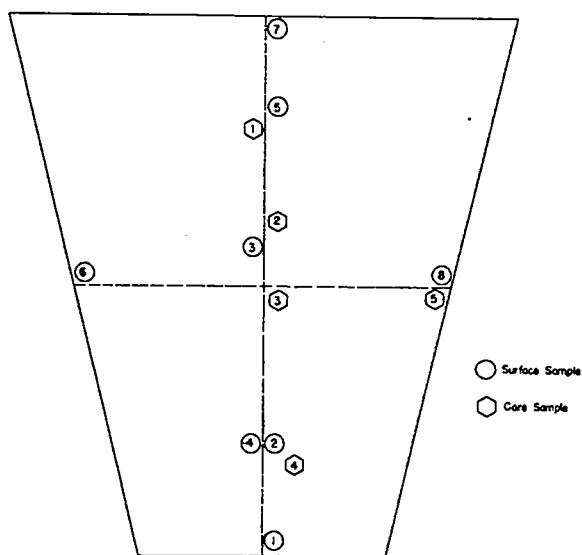

Fig. 37. Locations of soil samples taken underneath intake plenum.

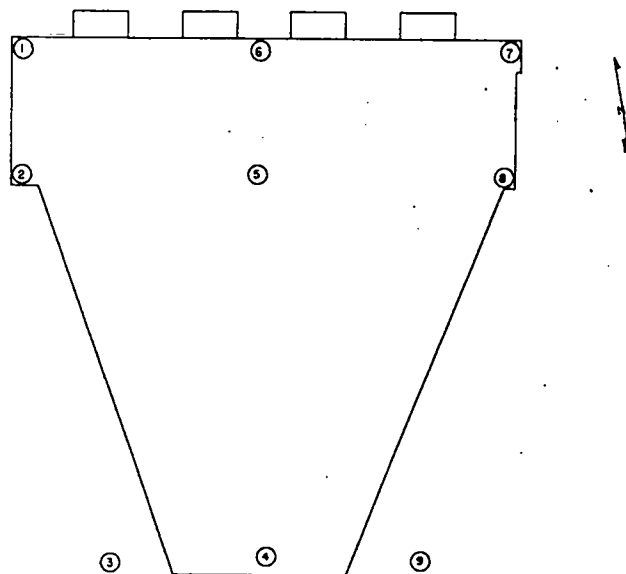

Fig. 38. Locations of soil samples taken from cleared site.